

# Unlocking Environmental, Social, and Governance Advantages Through Hygiene Management in Plumbing Systems: The Smart U-Trap Refill Mechanism's Role in Pandemic Control

Mohammad Hady Makhmalbaf<sup>1,\*</sup>, Siu Tung LUI<sup>1</sup> and Corina Man Ngo CHENG<sup>1</sup>

1- Independent researcher, Livonia, Michigan, USA

\*Corresponding Author: [hady.makhmalbaf@wmich.edu](mailto:hady.makhmalbaf@wmich.edu), [tommy@simplymask.com.hk](mailto:tommy@simplymask.com.hk), [corina@simplymask.com.hk](mailto:corina@simplymask.com.hk)

---

## ABSTRACT

Efficient and hygienic plumbing systems are paramount for maintaining the health and well-being of inhabitants in both residential and commercial spaces. Traditional U-trap systems play a vital role in preventing the ingress of foul odours, hazardous gases, and vermin from sewage lines into living and working areas. However, these U-trap systems have not been designed to address the challenges posed by infectious diseases. In response to this challenge, we present a groundbreaking solution – the Smart U-Trap Refill Mechanism called “Smart ESG U-traps”. This paper introduces the design, functioning principles, and potential benefits of this innovative refill mechanism, shedding light on its capacity to revolutionize the field of plumbing and sanitation. Through an interdisciplinary approach that combines principles of fluid dynamics, materials science, and engineering design, the Smart U-Trap Refill Mechanism addresses the synergy of U-Trap and Internet of Things technology. This synergy elevates the overall efficiency and reliability of real-time hygiene management in plumbing systems. The paper serves as a comprehensive guide for industry professionals, offering insights into the development, implementation, and advantages of our “Smart ESG U-traps” in various plumbing applications.

**Keywords:** Smart U-trap Refill Mechanism, Smart ESG U-traps, Plumbing systems, Internet of Things technology; Real-time data predictions; hygiene management; pandemic control; COVID-19

---

## 1. INTRODUCTION

Plumbing systems represent an integral component of modern infrastructures, ensuring the safe removal of waste materials while maintaining a clean and hygienic living and working

environment. The U-trap, a fundamental component of plumbing systems, acts as a barrier that prevents the entry of undesirable elements such as foul odours, hazardous gases, and vermin into habitable spaces. However, traditional U-trap systems have not been designed to address real-time management and control of infectious diseases like the COVID-19 pandemic, which leads to reduced functionality and potential health hazards. To address this challenge, we present our Smart Auto-Refill U-Trap Mechanism, a novel innovation that revitalizes traditional U-trap systems with the powerful combination of U-Trap and Internet of Things (IoT) technology, ensuring consistent and reliable operation.

This paper elucidates the design, operation, and anticipated Environmental, Social, and Governance (ESG) advantages of our “Smart ESG U-traps”. By combining principles from fluid dynamics, materials science, and engineering design, this mechanism aims to mitigate the deficiencies of traditional U-trap systems, thereby augmenting the efficiency and performance of plumbing systems. The “Smart ESG U-traps” introduces a paradigm shift in plumbing technology, offering a solution that has the potential to transform the way plumbing systems are conceived, constructed, and controlled. Through a comprehensive analysis, we aim to highlight the significance of the “Smart ESG U-traps” as a cornerstone of future plumbing innovations, fostering improved hygiene, sustainability, and operational efficiency.

## 2. Methodology

### 2.1 How does our product work?

Introducing a groundbreaking advancement in pandemic control, the synergy of U-Trap and Internet of Things (IoT) technology forms a powerful combination. Our innovative “Smart ESG U-traps”, seamlessly integrated with IoT sensors, redefines the landscape of hygiene management. Through a robust wireless connection, either via Wi-Fi or Bluetooth, the “Smart ESG U-traps” establishes a direct link to our dedicated IoT Server, effectively channelling data into a comprehensive database for advanced analytics (see Figure 1).

The pivotal element lies in the digitized capture of measurements. By collating historical data, our system empowers us to unveil subtle trends and patterns in U-shape barrier device malfunctions. This invaluable insight into the performance of U-traps paves the way for targeted interventions and optimized maintenance strategies. Leveraging the immense potential of big data, our solution enables real-time data predictions. This dynamic capability, honed through meticulous analysis, forecasts instances when specific U-shape air traps necessitate more frequent water refilling. Additionally, our “Smart ESG U-traps” acute sensitivity to hygiene concerns facilitates the prediction of potential issues that could exacerbate the spread of COVID-19 and other pathogens.

Notably, our technology fosters seamless communication between pertinent parties. The system generates alerts that can be instantly shared with relevant stakeholders. This rapid dissemination ensures that timely preventive measures are executed precisely where they are required, effectively curbing the transmission of infections in precise locations. In essence, the fusion of U-Trap and IoT technology charts a path toward an elevated realm of pandemic control. With data-driven insights, predictive capabilities, and swift communication mechanisms, our solution redefines the standards of anti-pandemic measures. Through this transformative integration, we empower communities and organizations to proactively safeguard public health and instil confidence in a safer future. We can prevent the failure of the “Smart ESG U-traps” as depicted in Figure 2.



**Figure 1** Smart ESG U-traps: U-Trap + Internet of Things (IoT) Solution in anti-pandemic control

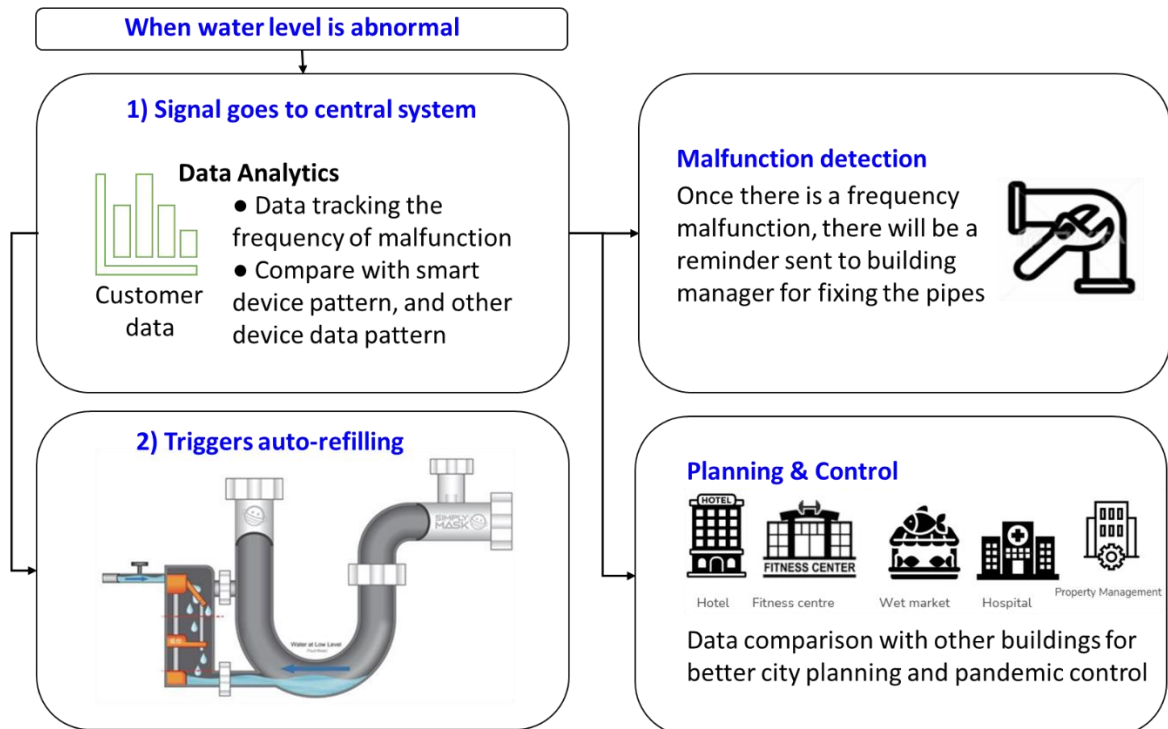
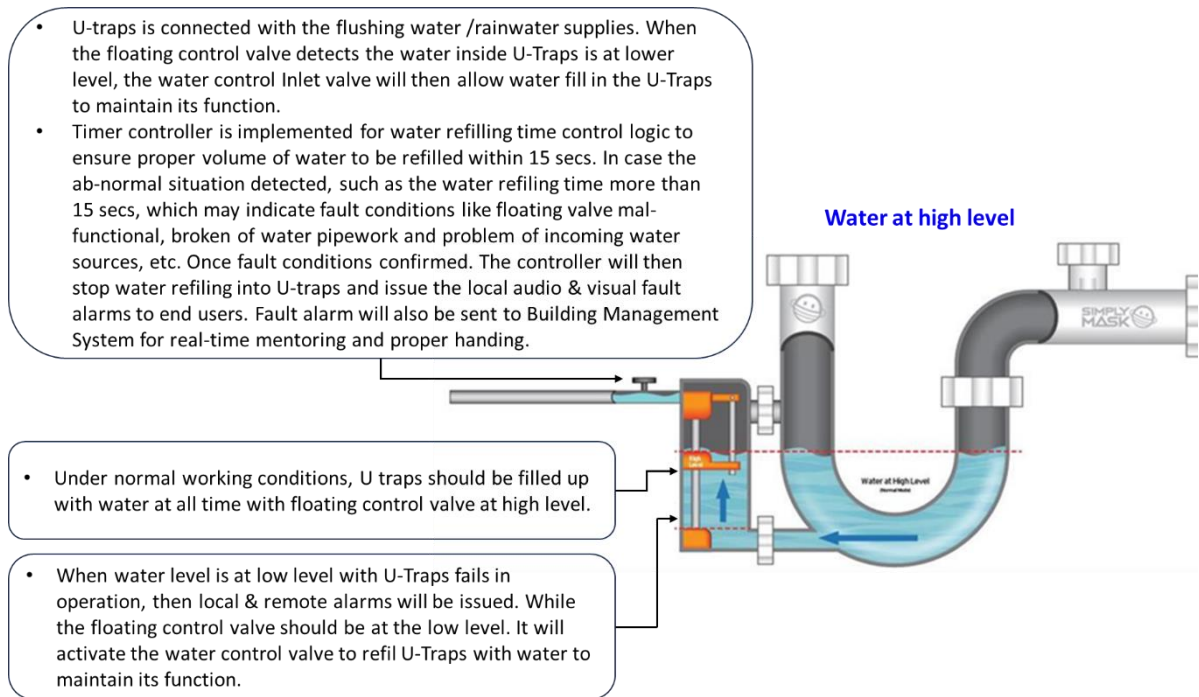

**Figure 2** How the “Smart ESG U-traps” solution prevents failure

2.2 How auto-refill U-trap prevent the loopholes of COVID-19?

The embodiment of this invention, “Smart ESG U-traps”, relates to the technical field of water drainage by applying Internet of Things (IoT) control for real-time management to a U-shaped water trap with anti-bacterial coating and drainage equipment. The U-shaped water trap includes a U-shaped pipe, wherein the side wall of the U-shaped pipe is provided with a water injection hole located at the bottom of the U-shaped groove formed by the U-shaped pipe a water tank consists of a water storage tank, a water inlet, and a water outlet. While a water outlet is in communication with the water storage tank and the water injection hole, the water inlet is provided with an electromagnetic valve switch for closing or opening the water inlet. A float switch is provided in the water storage tank for detecting the water level of the water storage tank.

The electromagnetic valve switch and the float switch are connected to the controller, which is used to control the electromagnetic valve switch to open when the float switch detects that the water storage tank is at a preset low water level, to inject water into the water storage tank, The U-shaped water trap can prevent the U-shaped pipe from being devoid of water, thus can prevent the U-shaped water trap from failing.



a) Normal Working Status of the “Smart ESG U-traps”

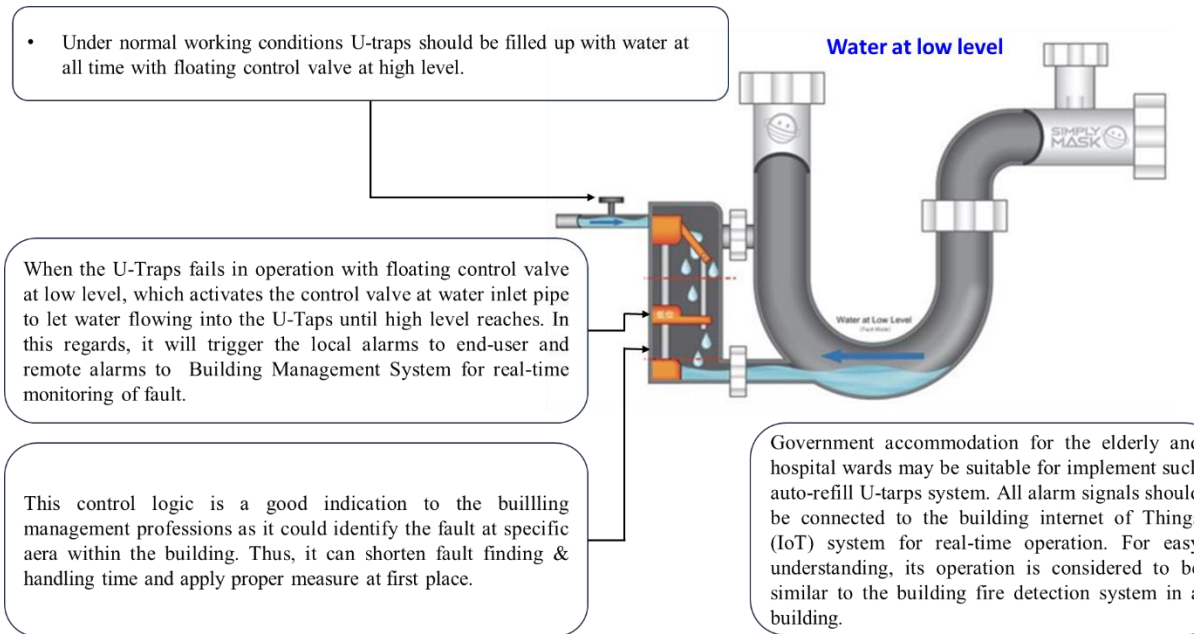

b) System fault Status of the “Smart ESG U-traps”

**Figure 3** “Smart ESG U-traps” mechanism connected to building management system via Internet of Things (IoT) system for real-time operation.

### 3. Innovation

This revolutionary creation, documented under the title "一種U型隔氣以及排水設備," marks a significant stride in the realm of innovative engineering. Bolstered by a Hong Kong short-term patent (No: HK30032726) and progressing towards a Chinese standard patent (Patent pending stage. No: 202121802430.7) after successfully clearing the preliminary examination, the “Smart ESG U-traps” embodies a fusion of mechanical ingenuity and cutting-edge IoT technologies. This innovation showcases the convergence of disciplines to address complex challenges, exemplifying our commitment to pioneering solutions that redefine industry standards (see Figure 4).

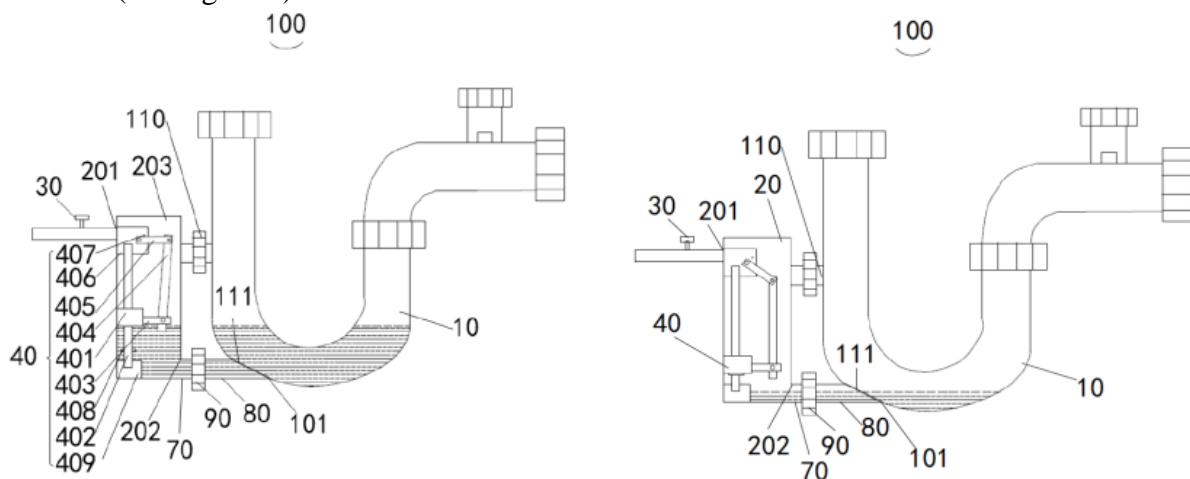

**Figure 4** The “Smart ESG U-traps”: bridging mechanical ingenuity and IoT advancements for industry redefinition

#### 4. Environmental, Social, and Governance Advantages

The Auto Refill U-Traps, branded as “Smart ESG U-traps”, offer a holistic solution that not only elevates drainage system performance but also delivers remarkable Environmental, Social, and Governance (ESG) advantages. These advantages are quantifiable, reflecting a commitment to sustainability, community well-being, and responsible corporate practices.

##### 4.1 Environmental Advantage: Water Conservation and Reduced Bleach Consumption

The integration of on-demand auto-refill technology into the U-Traps product line makes a direct and significant contribution to environmental conservation. In contrast to the traditional manual weekly refill method, the “Smart ESG U-traps” innovative approach ensures that water is utilized only when it is genuinely needed, leading to a considerable reduction in overall water consumption. This inherent efficiency not only helps in minimizing water wastage but also plays a crucial role in preserving our precious and finite water resources. Furthermore, the automatic refilling system has the potential to make a substantial difference by reducing the necessity for weekly bleach usage. Bleach, often employed to combat unpleasant odours and maintain the hygiene of U-traps, has a significant environmental impact due to its chemical composition and production processes. By implementing the “Smart ESG U-traps” automatic refilling system, we can either eliminate or greatly reduce the need for bleach usage, resulting in a substantial reduction in chemical consumption and the associated ecological footprint. To summarize:

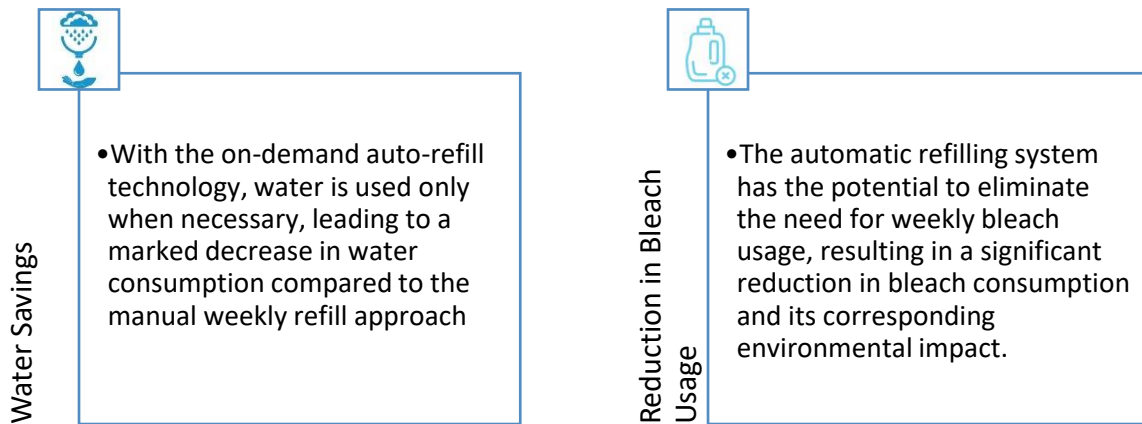

##### Social Advantage: Enhanced Health, Safety, and Convenience

The societal benefits of Simply U extend to the realm of health and safety. By preventing the development of foul odours, insects, harmful gases, and potential pest infestations caused by dry U-traps, the product contributes to healthier and safer living environments for residents. This advantage is particularly crucial in multi-residential and commercial settings, where the absence of such hazards enhances overall well-being.

Additionally, “Smart ESG U-traps” introduces a new level of convenience for residents. The burdensome task of manually refilling U-traps every week becomes a thing of the past. The automation of this process not only reduces maintenance-related efforts but also frees up time for residents, enabling them to focus on more meaningful pursuits. To summarize:

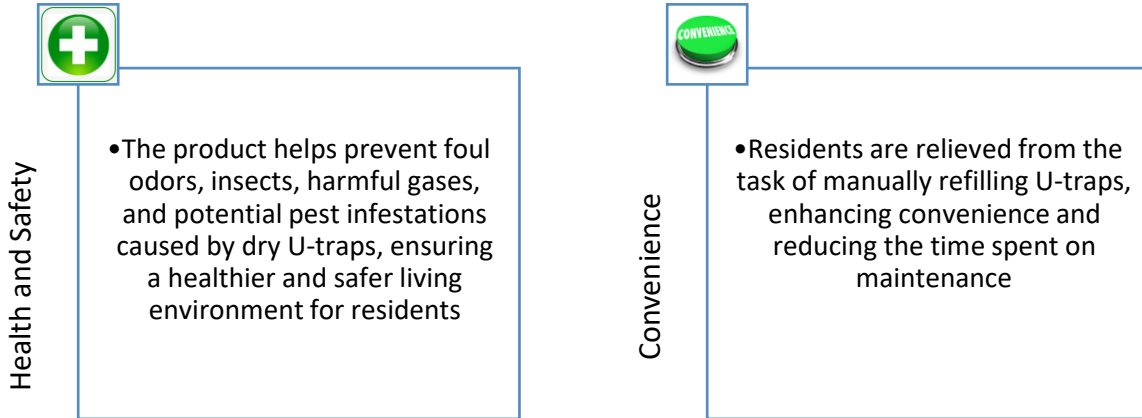

#### 4.2 Governance Advantage: Regulatory Compliance and Technological Innovation

The “Smart ESG U-traps” hold a strong position in governance and regulatory compliance. In a world that has witnessed the significance of proper sanitation practices during health crises such as COVID-19, these products align seamlessly with governmental guidelines. By ensuring consistently functioning U-traps that eliminate the risks associated with dry traps, “Smart ESG U-traps” supports authorities' efforts to maintain public health and safety. Moreover, the incorporation of advanced auto-refill technology showcases a dedication to innovation and sustainable practices. The product stands as a testament to a commitment to proactive problem-solving within the drainage domain, reflecting positively on the governance framework of any organization. By embracing this cutting-edge solution, companies exemplify their commitment to responsible environmental stewardship and technological advancement. To summarize:

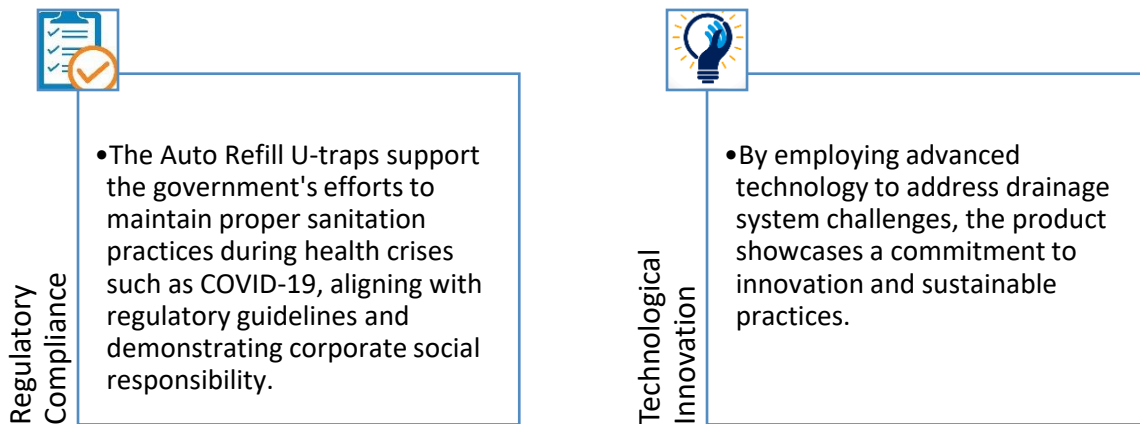

In conclusion, the “Smart ESG U-traps” emerge as an exemplary embodiment of ESG values. Their capacity to conserve water, reduce chemical usage, enhance health and safety, and align with regulatory standards underscores their multifaceted contribution to a more sustainable, equitable, and responsible future.

#### 4.3 Quantifying ESG Advantages in Hong Kong: A Case for Smart Auto-Refill U-Traps

To contextualize the substantial ESG advantages offered by the “Smart ESG U-traps” in Hong Kong, we turn our attention to the local residential landscape. Hong Kong, a densely populated urban hub, is home to approximately 2.6 million families, each representing a potential drainage point in need of effective U-trap management [1]. This scale highlights the significance of optimizing drainage practices for environmental, social, and governance benefits. Currently, the prevailing approach involves manual weekly U-trap refilling, utilizing 500ml of water each week [2]. This practice not only entails considerable water usage but also

involves the regular consumption of bleach. The Auto Refill U-Traps technology introduces a transformative shift in drainage system management, offering a solution that significantly reduces water usage and eliminates the need for weekly bleach application. The cumulative effect of these changes translates into noteworthy environmental benefits, further aligning with environmental and health regulations and enhancing living conditions.

To provide a more accurate understanding of the potential impact, a preliminary assessment is conducted. Assuming that each of the 2.6 million families in Hong Kong manually refills their U-traps with 500ml of water weekly and accounting for the natural drying process over a span of 10 weeks (which may necessitate simulation for validation), an estimated 90% of water could be saved each week on average. This calculation yields the following insight:

$$\begin{aligned} & \text{Total water saved per week.} \\ & = (\text{Number of families}) \times (\text{Water saved per family}) \\ & = 2,600,000 \text{ families} \times 500\text{ml} \\ & = 1,300,000,000 \text{ ml} \\ & = 1,300,000 \text{ liters} \times 90\% \\ & = 1,170,000 \text{ liters} \\ & \text{Total water saved per day.} \\ & 1,170,000 \text{ Liters} / 7 = 167,142 \text{ Liters} \\ & \text{Total water saved per month (30day).} \\ & 167,142 \text{ Liters} \times 30 = 5,014,260 \text{ Liters} \end{aligned}$$

So, if all residential drainage points in Hong Kong were equipped with “Smart ESG U-traps”, it could potentially save around 5,014,260 Liters of water consumption per month by eliminating the need for manual U-trap refilling. This is a significant environmental benefit that demonstrates the ESG advantages of the technology.

#### 4.4 Further study: Potential reduction the indirect GHG emissions (Scope 3) due to electricity consumption of fresh water and sewage water

This study delves into the potential reduction of indirect greenhouse gas (GHG) emissions categorized under Scope 3, stemming from the electricity consumption associated with the processes of fresh water and sewage water management. It explores the often-overlooked environmental impact of electricity use for the treatment of fresh water by the Water Supplies Department (WSD) and the processing of sewage by the Drainage Services Department (DSD). The calculations presented aim to provide a preliminary understanding of the potential GHG emissions and water savings, but it is crucial to recognize the complexity of these systems. Real-world outcomes may vary significantly due to factors such as regional variations, usage patterns, and technological intricacies. This analysis serves as a starting point, emphasizing the need for a comprehensive approach and expert assessments when addressing water savings and GHG emissions reduction in these critical processes.

##### 4.4.1 Other indirect GHG emissions due to electricity used for processing freshwater by the water supplies department (WSD)

$$\begin{aligned} & = 5,014,260 \text{ Liters} \\ & = 5,014.26 \text{ m}^3 \text{ (meter cube)} \\ & \text{Provided that Emission (CO}_2\text{-e)} \\ & = \text{Quantity of fresh water consumed} \times \text{Emission factor where water consumed is} \end{aligned}$$



measured in cubic metre

The assumed emission factor [3] is from 0.45 kg CO<sub>2</sub>-e/m<sup>3</sup>.

$$= 5,014 \text{ m}^3 \times 0.45 / 1,000$$

$$= 2.26 \text{ Ton (CO}_2\text{-e)}$$

#### Indirect GHG Emissions due to Electricity Used for Processing Sewage by the Drainage Services Department (DSD)

$$= 5,014,260 \text{ Liters}$$

$$= 5,014.26 \text{ m}^3 \text{ (meter cube)}$$

Provided that Emission (CO<sub>2</sub>-e)

= Quantity of sewage water consumed × Emission factor where Water consumed is measured in cubic

metre (m<sup>3</sup>)

The assumed Emission factor [3] is from 0.16 kg CO<sub>2</sub>-e/m<sup>3</sup>.

$$= 5,014 \text{ m}^3 \times 0.16 / 1,000$$

$$= 0.8 \text{ Ton (CO}_2\text{-e)}$$

In conclusion, the calculations presented here underscore the significant environmental impact of our innovative product in addressing indirect greenhouse gas (GHG) emissions associated with water management. By reducing the electricity consumption in the processing of fresh water and sewage, our product has the potential to make a substantial contribution to lowering these emissions. With 2.26 tons of CO<sub>2</sub> equivalent emissions attributed to freshwater processing and 0.8 tons linked to sewage treatment, it becomes evident that our innovation can play a vital role in mitigating Scope 3 GHG emissions. This data reinforces the importance of our ongoing efforts to develop sustainable and eco-friendly solutions that not only benefit our business but also contribute to a greener, more environmentally responsible future. It underscores the potential for our product to be a catalyst for positive change in the broader context of environmental conservation and carbon reduction.

#### 4.5 Preventing Drainage Trap Drying with Smart ESG U-Traps

Our innovative "Smart ESG U-traps" offer a solution to reduce the common issue of U-traps drying out. Drainage traps are especially susceptible to this problem when left unused for extended periods, typically between one to five months [4]. The exact duration hinges on various factors, such as local climate conditions and usage patterns. In regions characterized by low humidity and infrequent water flow, the drying process can be expedited [5]. Furthermore, the timeframe for a drainage trap to naturally dry out is influenced by several elements, including siphonage, back pressure, evaporation, capillary attraction, and wind effect. Among these factors, siphonage and back pressure emerge as the most prevalent culprits behind trap seal loss [6]. Research indicates that the drying time for a U-trap can vary significantly depending on factors like local climate, humidity levels, and usage patterns. In humid environments, U-traps may take longer to dry out compared to arid areas. Regular usage and the consistent flow of water through the U-trap also contribute to its longevity. As a rough estimate, in a typical household with regular usage and moderate climatic conditions, a U-trap may not completely dry out for one to five months. However, this estimate is general and may vary depending on specific circumstances.

To address these challenges, our "Smart ESG U-traps" seamlessly integrate with Internet of

Things (IoT) technology, revolutionizing hygiene management in plumbing systems. Equipped with IoT sensors, these U-traps establish direct connections to our dedicated IoT server, forming a dynamic network that continuously monitors their water seal status. Real-time data collection and analysis identify subtle trends and patterns in U-trap malfunctions. Leveraging big data analytics, our system can predict when specific U-traps are at risk of drying out, allowing for timely interventions. Moreover, our technology promotes seamless communication between stakeholders by generating instant alerts shared with relevant parties. This ensures that preventive measures are implemented precisely where needed, effectively containing the spread of infections in specific locations. In this study, we considered an average baseline of 2.5 months (approximately 10 weeks) as the time for U-trap drainage to naturally dry out. This estimate serves as a reference point for water-saving calculations. However, we acknowledge the need for further research to refine the estimation of U-trap drying times in various scenarios and property types.

## 5. Summary

The "Smart ESG U-traps" represents a groundbreaking solution that addresses the critical need for efficient and hygienic plumbing systems in both residential and commercial spaces. Traditional U-trap systems, while effective in preventing the ingress of foul odours and hazardous gases, have been ill-equipped to tackle the challenges posed by infectious diseases such as COVID-19. This innovation combines U-Trap technology with the power of the Internet of Things (IoT) to create a Smart U-Trap Refill Mechanism, redefining the landscape of plumbing and sanitation.

Through an interdisciplinary approach involving principles of fluid dynamics, materials science, and engineering design, the "Smart ESG U-traps" offers real-time hygiene management capabilities that enhance overall efficiency and reliability in plumbing systems. By seamlessly integrating with IoT sensors and establishing a connection to a dedicated IoT server, this mechanism allows for the digitized capture of measurements, enabling data-driven insights, predictive capabilities, and swift communication. In essence, it provides a paradigm shift in pandemic control and hygiene management.

Furthermore, the "Smart ESG U-traps" comes with significant Environmental, Social, and Governance (ESG) advantages. It promotes water conservation by ensuring that water is used only when needed, reducing overall water consumption and diminishing the need for weekly bleach application. This not only benefits the environment but also enhances health and safety by preventing the development of foul odours and harmful gases in U-traps. The convenience it offers to residents further contributes to their well-being.

In addition, the product aligns with regulatory guidelines, supporting authorities' efforts to maintain public health and safety, particularly during health crises like COVID-19. The potential impact of implementing the "Smart ESG U-traps" in Hong Kong, with its densely populated urban landscape, could result in substantial water savings and environmental benefits. Moreover, by reducing the electricity consumption associated with processing fresh water and sewage, the product has the potential to make a significant contribution to lowering indirect greenhouse gas emissions.

In conclusion, the "Smart ESG U-traps" embodies a commitment to a greener, healthier, and more responsible future. Its innovative approach to plumbing and sanitation addresses critical challenges and offers multifaceted advantages that extend beyond the realm of hygiene management. This product has the potential to revolutionize plumbing systems, making them more efficient, sustainable, and aligned with the principles of environmental stewardship and technological advancement.

## References

- [1] <https://www.statista.com/statistics/318746/hong-kong-number-of-domestic-households/>
- [2] [https://www.chp.gov.hk/files/pdf/utrap\\_en.pdf](https://www.chp.gov.hk/files/pdf/utrap_en.pdf)
- [3] [https://www.carbon-footprint.hk/common/PDF/EPD\\_CA\\_Guidebook\\_Office\\_English.pdf](https://www.carbon-footprint.hk/common/PDF/EPD_CA_Guidebook_Office_English.pdf)
- [4] <https://plumberous.com/how-fast-can-a-p-trap-dry-out/>
- [5] <https://www.edwardsplumbingllc.com/blog/2020/december/how-to-eliminate-odors-coming-from-your-dry-p-tr/>
- [6] <https://www.cdc.gov/nceh/publications/books/housing/cha09.htm>